

PRODUCT INFORMATION MODEL 2301 CHARLES

© 2018 KURT BEIER & KATI QUINGER



Functional chair with armrests



360° rotary function



Cushion









Simple handling
by sensor buttons

CHARLES: THE ULTIMATE WING CHAIR. TAKE A LITTLE BIT OF EXTRAVAGANCE, A PINCH OF ECCENTRICITY AND MIX IT WITH THE ATTRIBUTES OF COSY, COMFORTABLE, RESTFUL AND THE WARMING ATMOSPHERE OF A FIREPLACE. THIS IDEA HAS LED US TO DEVELOP AN ARMCHAIR BASED ON MODERN TECHNOLOGY WITH THE BEST SITTING AND LYING COMFORT AND EXCELLENT OPERABILITY. OUR LARGE COLLECTION OF SPECIAL TEXTILES AND LEATHER QUALITIES ENSURES THE BEST SUIT. CHARLES - A REMINISCENCE OF THE PAST PAIRED WITH THE TECHNOLOGY OF TODAY. UNIQUE PIECE PRODUCTION.

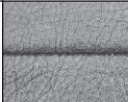
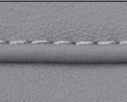
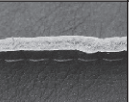

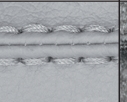
Lower frame, armchair; base plate with rotary system, round (ø 60 cm): optionally made of metal, powder-coated fine structure in black matt or metal with stainless steel cover (extra charge)
Attention! maximum load: up to 120 kg

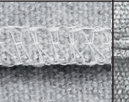
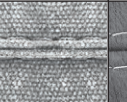
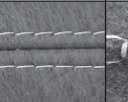
Processing options of main seam / decorative seam

	Plain seam	Lap seam	Raw edged	Moccasin seam extra charge	Twin seam extra charge	KR* (zipper piping) extra charge	Overcast seam extra charge	Piping	Two needle seam	Square seam extra charge
										
Fabric	x									
Leather	x		x							
Fur										
Fake fur	x									

It is possible to order main seam or decorative seam either tone in tone like the colours of cover or in the contrasting colours white, nature, grey, rust and black. On request special colours possible.

*Zipper piping: optionally in the colours black, red, nature or light grey.

Dividing seams for leather processing:



13.06.2023

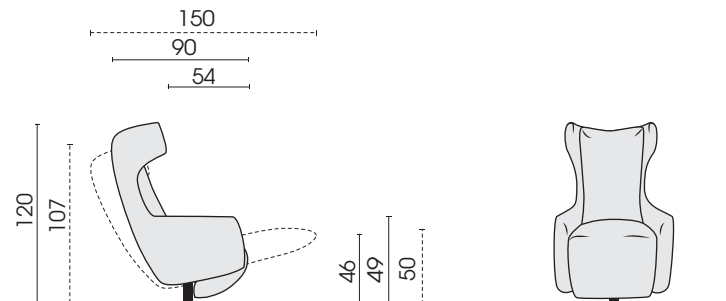

Side view, 100F

Wing chair, narrow

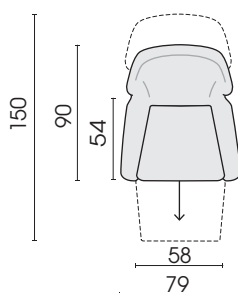

Functional chair
rotatable
2 armrests
100F

Cushion



Cushion
(tapered cushion)
(Fabric: plain seam or piping)
(Leather: raw edged)
40 x 30
937



Front side



Back side

Standard version for motorised drive:

- touch it
- power supply

Optionally with battery for an extra charge.

Each piece of furniture is handmade and unique. Deviations to the listed measurements may be caused by:
1. different upholstery materials (fabric, leather), 2. processing of ticking mats, 3. the pressure to combine individual parts, etc.
The seat comfort of a sofa type with larger seat depth usually differs from one with lower depth.